

**ORDER / QUOTATION FORM**

Customer Name: .....

Project: .....

QUOTE

Customer Ref: .....

Date: .....

ORDER

ALWAYS USE A METAL MEASURING TAPE. ALL BLINDS/SCREENS ARE MADE ACCORDING TO THE INFORMATION AND MEASUREMENTS SUPPLIED. THE MANUFACTURER CANNOT BE HELD RESPONSIBLE FOR INCORRECT INFORMATION GIVEN BY A CUSTOMER

**PLEASE NOTE: THE NUMBERED COLUMNS IN THE TABLE CORRESPOND TO THE ILLUSTRATIONS OVERLEAF**

ITEM REF	SCREEN / BLIND TYPE [ 1 ]	SHAPE [ 2 ]	FIXING BRACKET TYPE [ 3 ]	ROLLER OPERATING MECHANISM [ 4 ]	WIDTH 'CW' or 'PW' [ 5 ]	BOTTOM RAIL WIDTH 'BR'	DROP 'RD'	INSIDE / OUT-SIDE RECESS	FILM OR FABRIC COLOUR [ 6 ]	CABLE SUPPORT Y / N [ 7 ]	SIDE GUIDE CHANNELS Y / N	REMARKS or REFERENCE	QTY

TO ENSURE A PROMPT AND ACCURATE REPLY TO YOUR ENQUIRY, PLEASE COMPLETE ALL OF THE COLUMNS AND ADD ANY REMARKS WHICH MAY BE USEFUL THEN EMAIL IT TO [SALES@SOLASOLV.COM](mailto:SALES@SOLASOLV.COM)

# INSTRUCTIONS

## [ 1 ] CHOOSE PRODUCT TYPE...

**SOLASAFE (SS)** FILM SUNSCREEN INSIDE AN ALUMINIUM CASSETTE  
**SOLAROLA (SR)** FILM SUNSCREEN WITHOUT AN ALUMINIUM CASSETTE

**CASSLITE (CL)** FABRIC ROLLER BLIND INSIDE AN ALUMINIUM CASSETTE  
**DIMMLITE (DL)** FABRIC ROLLER BLIND WITHOUT AN ALUMINIUM CASSETTE

**LITETITE (LT)** BLACKOUT BLIND INSIDE AN ALUMINIUM CASSETTE WITH INNER AND OUTER SIDE CHANNELS

## [ 3 ] CHOOSE BRACKET TYPE...

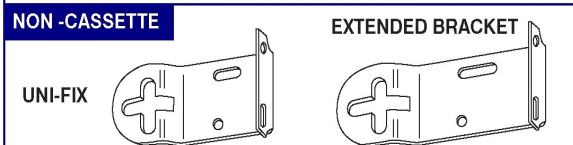
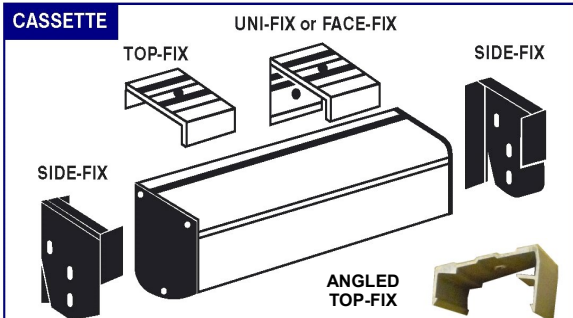

UNI-FIX BRACKETS ALLOW THE SCREEN / BLIND TO BE BOTH TOP FIXED AND FACE FIXED. IF UNSURE CHOOSE THESE BRACKETS.

FOR INVERTED INSTALLATIONS CHOOSE UNI-FIX

FOR INCLINED WINDOWS 15°+ FROM THE VERTICAL CHOOSE ANGLD TOP-FIX BRACKETS

### CODE

**TF** = TOP-FIX  
**ATF** = ANGLD TOP-FIX  
**UF** = UNI-FIX  
**SF** = SIDE-FIX

## [ 2 ] CHOOSE SCREEN / BLIND SHAPE...

\*N.B. FOR UNEQUAL TAPERS THE LEFT HAND OFFSET (LHO) MUST BE SUPPLIED AS WELL AS THE BOTTOM RAIL (BR) WIDTH\*

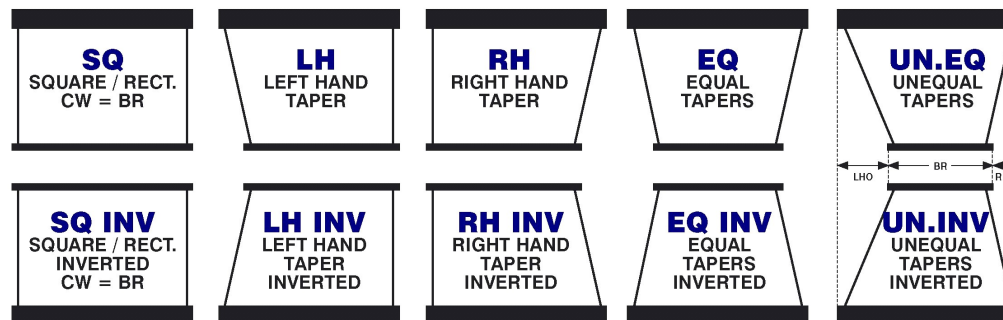

## [ 4 ] CHOOSE OPERATING SYSTEM...

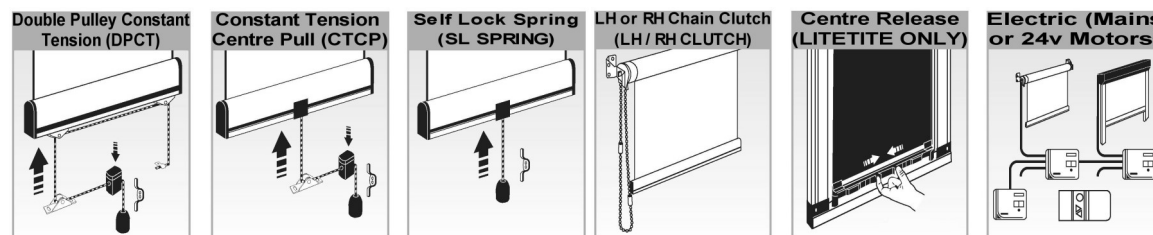

**DPCT** = CONSTANT TENSION SPRING WITH DOUBLE PULLEY BOTTOM RAIL

**CTCP** = CONSTANT TENSION SPRING WITH CENTRE PULL

**LH CLUTCH** = LEFT HAND CHAIN CLUTCH

**ELECTRIC** = MAINS POWER OR 24V MOTORS

**SL SPRING** = SELF LOCK SPRING

**RH CLUTCH** = RIGHT HAND CHAIN CLUTCH

**BATTERY** = BATTERY OPERATION WITH REMOTE

## [ 5 ] MEASURING INSTRUCTIONS...

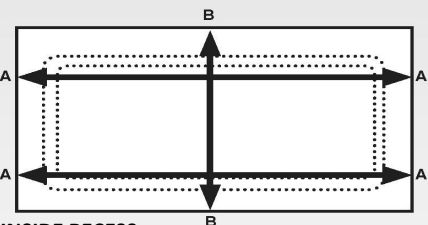

### INSIDE RECESS

Carefully measure **width 'A'** at two points to identify the recess and window shape e.g. square or tapered. Use the smallest size for **'A'** and mark as **INSIDE** recess. Solar Solve will then deduct 6 mm from the width. This is the **WIDTH** dimension (also known as the **CW=Cassette Width** on the SOLASAFE screen or **PW=Pin Width** on the SOLAROLA screen). Carefully measure **'B'** as the **DROP** dimension.

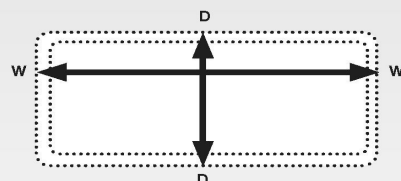

### OUTSIDE RECESS

Decide where the blind/screen is to be installed and carefully measure the **width 'W'** and **drop 'D'**. Give the width dimension **'W'** as **CW = Cassette Width** or **PW = Pin Width** and the dimension **'D'** as the **drop RD = Required Drop**.

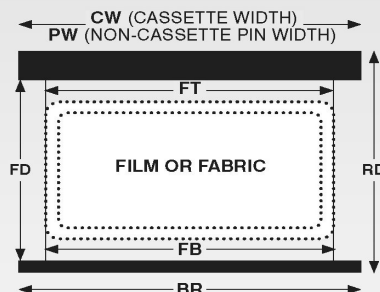

**FT** = Film / Fabric Top Width (CW or PW less 38mm)  
**FB** = Film/Fabric Bottom Width (BR less 38mm)  
**FD** = Film/Fabric Drop  
**BR** = Bottom Rail Width  
**RD** = Required Drop

## [ 6 ] CHOOSE FILM COLOUR

### SOLASOLV

#### FILM COLOURS AVAILABLE

Name	INSide	OUTSide
<b>GOLD</b>	Grey	Gold
<b>SILVER</b>	Grey	Silver
<b>GREY</b>	Grey	Grey
<b>BRONZE</b>	Bronze	Bronze

## [ 7 ] OPTIONS...

